

VCD-Series Quick-Start Addendum

1900 Wellworth
Jackson, MI 49203



FOR MOST INSTALLATIONS (Read all steps before installation – not necessarily in order) **9/25/2023**

1. **CONFIRM PROPER CHARGE, AIRFLOW, SYSTEM ORIENTATION** - The VCD-Series of inverter heat pumps are designed and manufactured to meet specific levels of AHRI-Rated efficiency when matched with appropriate Air Handlers and Coils. Failure to confirm may reduce energy efficiency, shorten equipment life, and cause nuisance service calls. Follow IOM information to ensure Air Handlers and Multiposition Coils are oriented in the right direction for airflow and drainage.
 - Systems are pre-charged for 25' of line set. Add 0.69oz per foot of additional line set beyond the factory-charged 25' length.
 - For Systems utilizing outdoor VCD heat pump systems *without* the factory match air handler, ensure airflows are nominal to the specific cfm rates in the tables provided in the IOM manual. This includes any furnace used with the match MCD-Series coil, or any other non-OEM air handler.
2. **CHOOSE CONTROL AND WIRING STRATEGY** – The VCD-Series can be uniquely fitted to a variety of control options, with designated specific wiring required.

A) Complete VCD System + Proprietary Programmable VCD Controller



VCD Controller

18/2 Stranded Shielded Recommended
18/2 Thermostat Wire Acceptable
*Non-Polarity Sensitive **HA/HB Terminals**



VCD Air Handler



VCD Outdoor HP

18/2 Stranded Shielded Recommended
18/2 Thermostat Wire Acceptable
***S1 / S2 Terminals**

B) Complete VCD System + 24VAC Thermostat Recommended 4H/2C HP Enabled

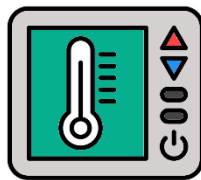

24VAC Stat

18/10 Thermostat Wire Recommended

- "R" 24VAC Hot
- "C" Common
- "G" Fan
- "B" Reversing Valve (ON - Heat)
- "Y1" 1st Stage Compressor
- "Y2" 2nd Stage Compressor
- "W1" 1st Stage Aux Heat
- "W2" 2nd Stage Aux Heat
- "E/AUX" Emergency Heat
- "L" Alarm (Optional)
- "DH" Dehum (Optional)



VCD Air Handler



VCD Outdoor HP

18/2 Stranded Shielded Recommended
18/2 Thermostat Wire Acceptable
***S1 / S2 Terminals**

Notes:

- *Not all thermostats work well – some bleed slight voltages which can cause erratic behavior.
- **"W" Terminal is not used.

VCD-Series Quick-Start Addendum

1900 Wellworth
Jackson, MI 49203



C) VCD Outdoor Unit + MCD Coil + Furnace + 24VAC Recommended Dual-Fuel Enabled Stat

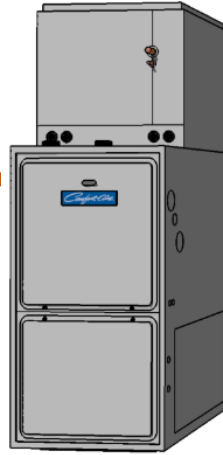
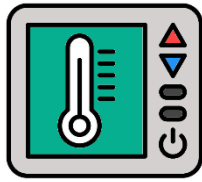

- 18/10 Thermostat Wire Recommended
- "R" 24VAC Hot
 - "C" Common
 - "G" Fan
 - "B" Reversing Valve (ON - Heat)
 - "Y1" 1st Stage Compressor
 - "Y/Y2" 2nd Stage Compressor
 - "W1" 1st Stage Furnace Heat
 - "W2" 2nd Stage Furnace Heat
 - "L" Alarm (Optional)
 - "DH" Dehum (Optional)

- 18/6 Thermostat Wire Recommended
- "R" 24VAC Hot
 - "C" Common
 - "B" Reversing Valve (ON - Heat)
 - "Y1" 1st Stage Compressor
 - "Y/Y2" 2nd Stage Compressor
 - "L" Alarm (Optional)

Notes:

- *Not all thermostats work well – some bleed slight voltages which can cause erratic behavior.
- **"W" Terminal is not used.
- *Must use Dual-Fuel Stat or Fossil Fuel Kit

Low Voltage Connection Points: Indoor Unit

24VAC Input from Standard 24VAC Thermostat

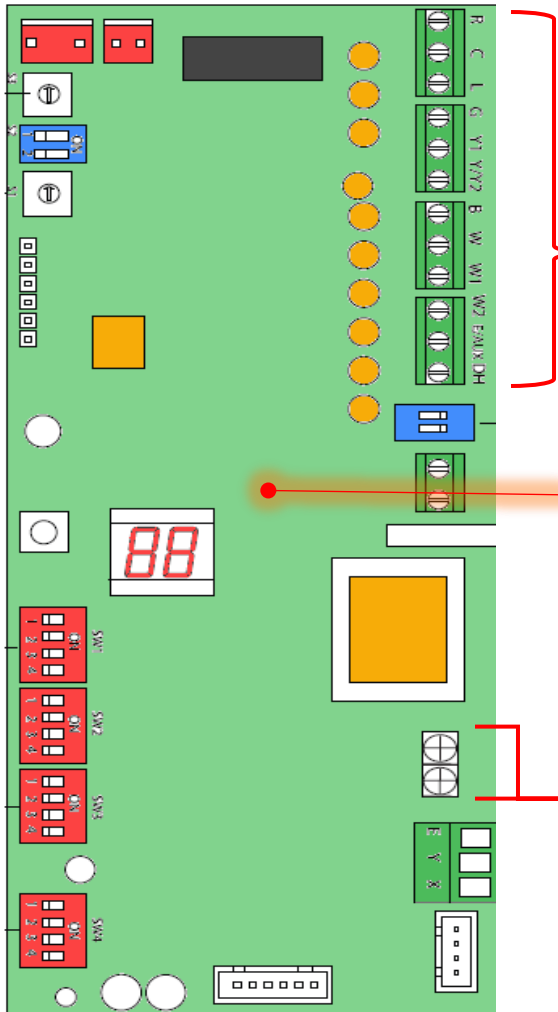

2-Wire Input from Proprietary VCD Thermostat (Non-Polarity Sensitive) HA/HB Terminals

VCD-Series Quick-Start Addendum

1900 Wellworth
Jackson, MI 49203



Low Voltage Connection Points: Indoor Unit (Cont'd)

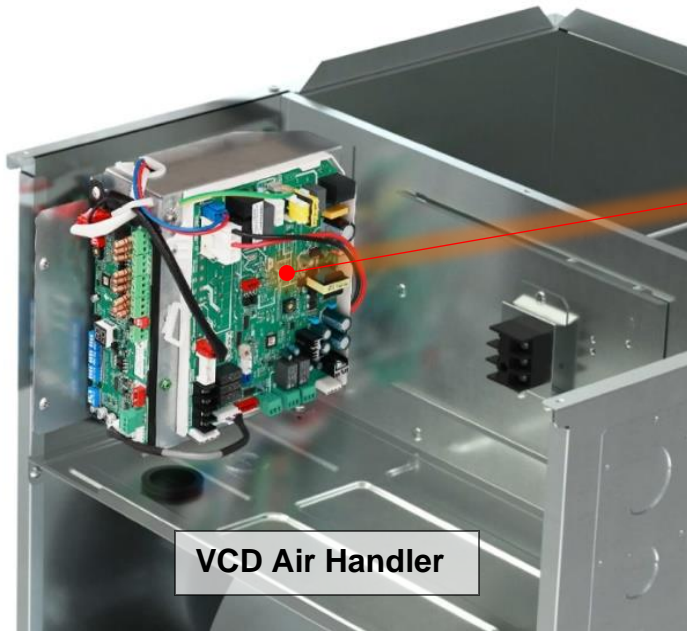

VCD Air Handler

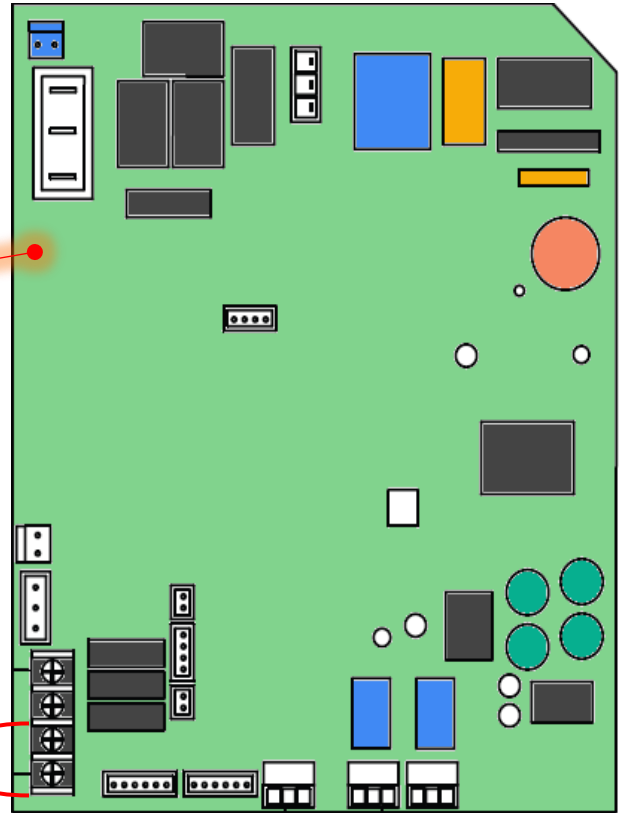

S1/S2 Output to Outdoor Unit (Polarity Sensitive)

Low Voltage Connection Points: Outdoor Unit

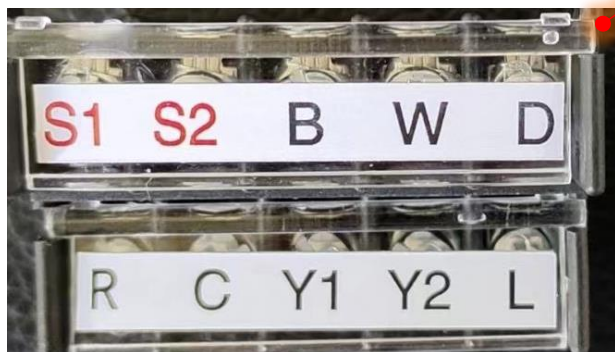

2-Wire (S1/S2) or 18/6 Thermostat Wire

- S1/S2 Polarity-Sensitive 2-Wire Connection
- "W" Heat Call - **Not Normally Used**
- "D" Defrost Call - **Not Normally Used**
- "R" 24VAC Hot
- "C" Common
- "B" Reversing Valve (ON - Heat)
- "Y1" 1st Stage Compressor
- "Y2" 2nd Stage Compressor
- "L" Alarm (Optional)

****WARNING: Do not apply 24VAC to S1/S2, irreversible damage will result**

VCD-Series Quick-Start Addendum

1900 Wellworth
Jackson, MI 49203



3. SET INDOOR AH DIPSWITCHES FOR APPLICATION – Power down before switch adjustments

SW1 Dipswitches (Default ALL OFF)

- Proprietary Controller + 2-Wire S1/S2 to Outdoor



- 24VAC Tstat 18/10 Wire + 2-Wire S1/S2 to Outdoor



- 24VAC Tstat 18/10 Wire + 18/6 to Outdoor

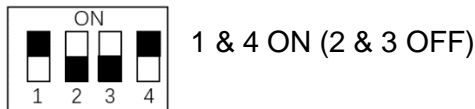

NOTE: SW1 dipswitch #2 controls “Anti-Cold” Fan-Stop during heating. To disable Fan-Stop during heating operation, turn switch ON.

SW2 Dipswitches (Default ALL OFF)

- Recommended



NOTE: SW2 dipswitch #4 can enable lockout of either auxiliary heat or compressor via outdoor temperatures using **Rotary Dial S3**. If desired, review Rotary Dial temperature chart in IOM. DEFAULT Position for switch and dial enable NO LIMIT.

SW3 Dipswitches (Default ALL OFF)

- Recommended

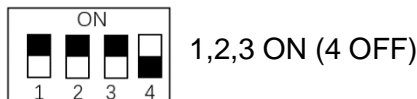

NOTE: SW3 dipswitch #4 can enable TURBO fan speed for cooling in 24VAC thermostats. If desired, turn ON to add approx. 10% more airflow in cooling.
For 24VAC Stats + VCD Air Handler ONLY.

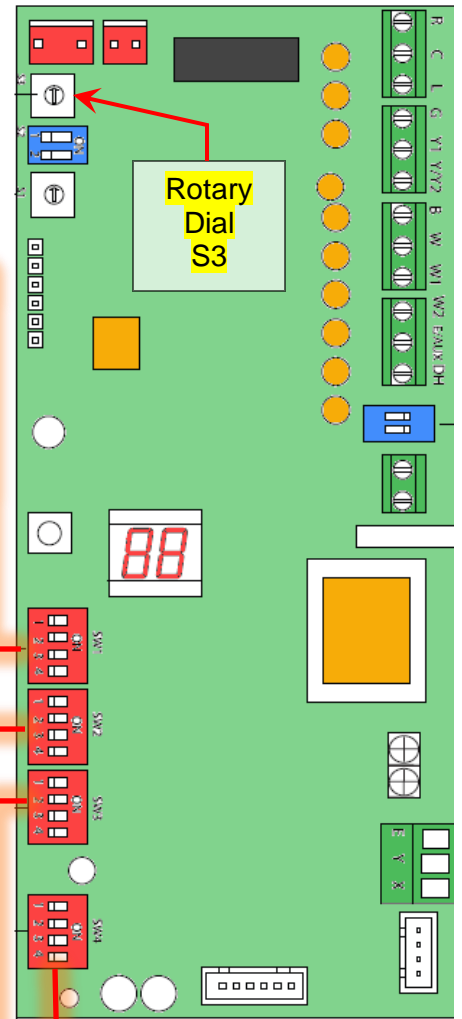

SW4 Dipswitches (Default ALL OFF)

- Recommended



NOTE: SW4 Dipswitches alter fan speed and is not recommended to change from factory settings.

VCD-Series Quick-Start Addendum

1900 Wellworth
Jackson, MI 49203



3. SET **INDOOR** AH DIPSWITCHES FOR APPLICATION – Power down before switch adjustments (Cont'd.)

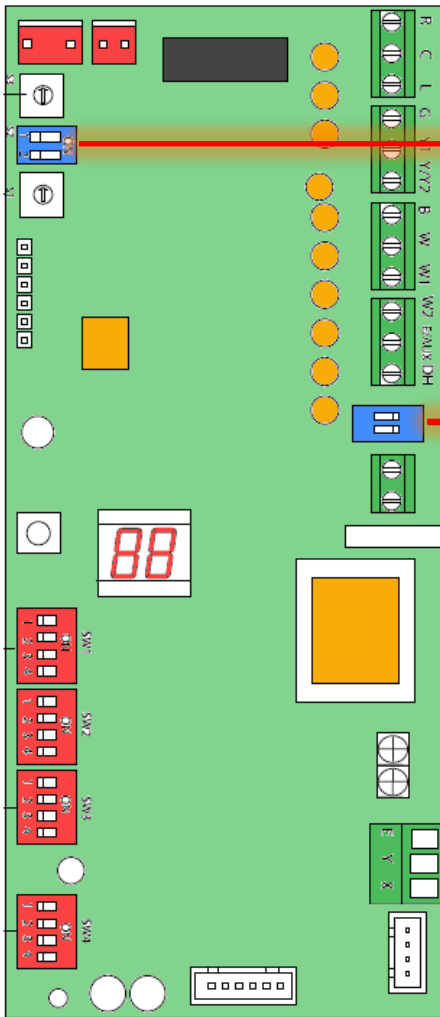

S2 Dipswitches (Default ALL OFF)



- Recommended ALL OFF

*NOTE: NOT USED

S4 Dipswitches (Default ALL ON)



- Recommended ALL ON

*NOTE: Dipswitch #1 in ON position enables W1 and W2 (Electric Heat Stg.1 and Stg 2) to be engaged simultaneously. OFF will stage W1 and W2 separately. Dipswitch #2 in ON position disables dehum feature for slower fan operation. To enable dehum feature, turn Dipswitch #2 OFF. Dehum feature requires 24VAC thermostat with dehum terminal or dehumidistat that removes a 24VAC signal upon a rise in humidity - resulting in lower fan speed during cooling. Warning: cooling may continue past setpoint to meet dehumidification causing some discomfort.

4. SET **OUTDOOR** DIPSWITCHES FOR APPLICATION – Power down before switch adjustments



CN6 Dipswitches (Default ALL OFF)

- 2-Wire S1/S2

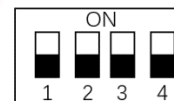

ALL OFF

- 18/6 Thermostat Wire



2,3 ON
1,4 OFF

VCD-Series Quick-Start Addendum

1900 Wellworth
Jackson, MI 49203



5. SINGLE-POINT CONNECTION KITS – where code requires, single-point supply wiring can be achieved through the following means:

A. For 5kW, 8kW, and 10kW Electric Heat Kits – in lieu of a separate circuit for the air handler, wire terminal block with appropriate gauge conductors from load-side of breaker. **Reference IOM and consult local and NEC wiring guidelines/codes.**

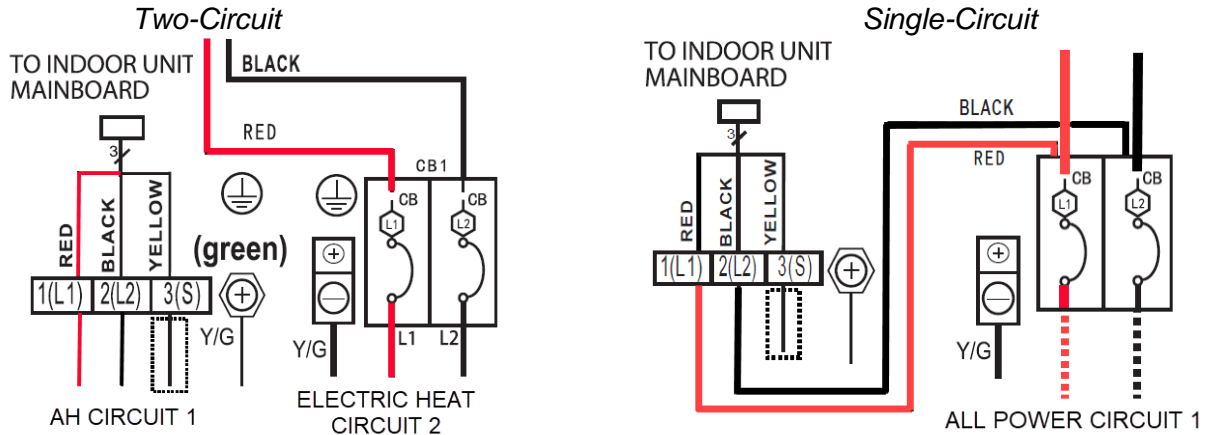

B. For 15kW or 20kW Electric Heat Kits – In lieu of a separate circuit for the air handler, wire terminal block with appropriate gauge conductors from load-side of breaker. Additionally, attach accessory **UEB1-701004-JPF Single Point Connection Kit** to line-side of dual breaker assembly. New Single-Circuit conductors must be the appropriate gauge for the requisite load capacity. **Reference IOM and consult local and NEC wiring guidelines/codes.**

- UEB1-701004-JPF Kit contains **Jumper Bar Base**, **Jumper Bar Cover**, and **Cover Screw**.

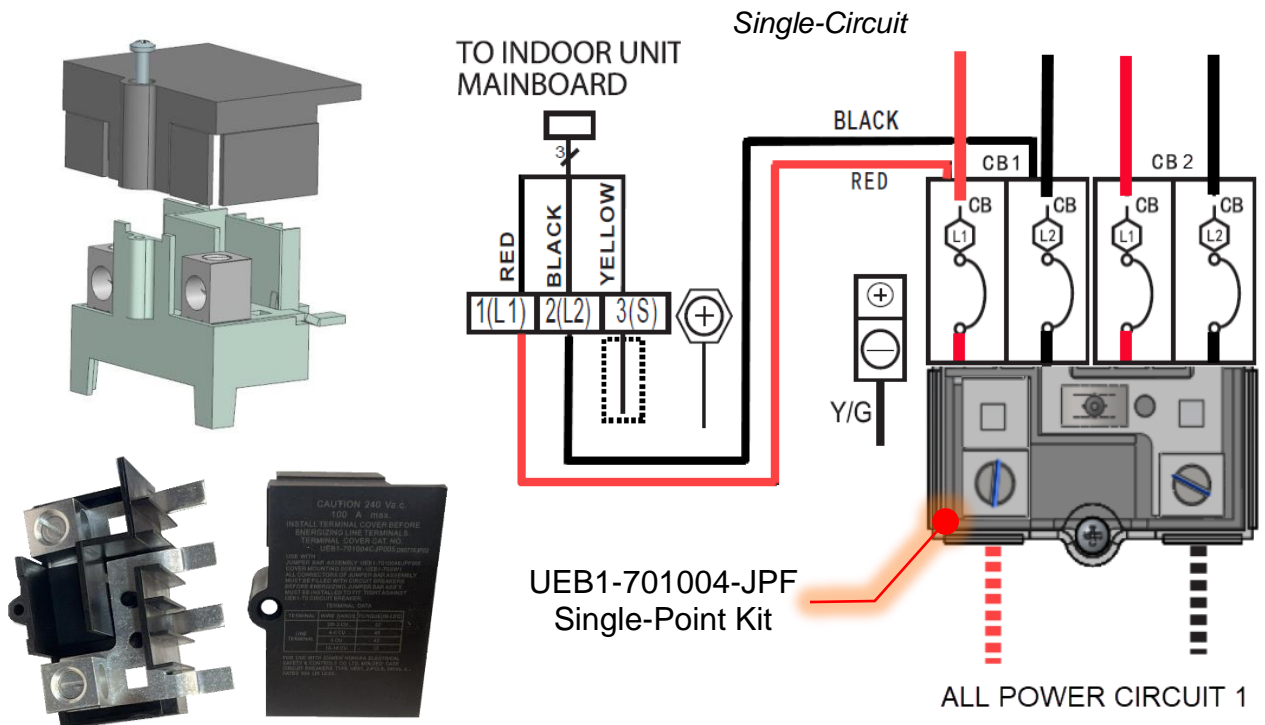

END>